

PerForm 2.0™ Hard Metric Connectors

Type AB, Male
IEC 61076-4-101

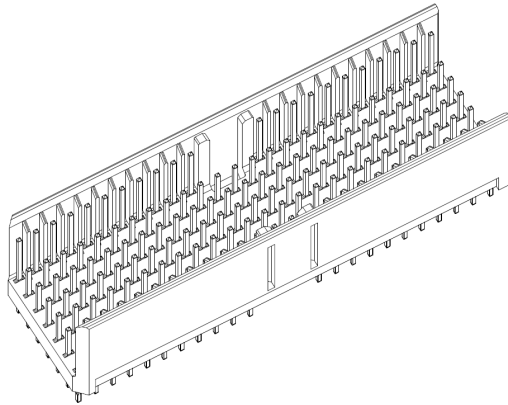
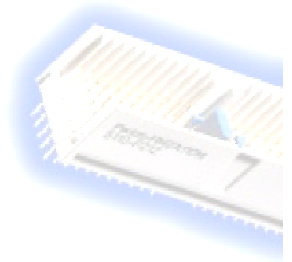

- According to IEC 61076-4-101 and IEC 917
- 25 mm basic system unit
- High contact density with 2 mm grid spacing
- 50 mm connector module
- Three different contact levels
- Different termination lengths available
- All terminations with compliant eye of needle press-fit design
- Plated through hole diameter 0.6 mm
- Available with grounding rows
- Different coding devices available

PRODUCT DATA

Electric data

Current rating	1 A at +70 °C
Test voltage	750 V AC (rms)
Insulation resistance	10 Gohm (min)
Temperature range	-55... +125 °C

Materials

Housing material	Thermoplastic resin, glass-fibre filled, UL 94 V-0
Contact material	Copper alloy
Contact plating	Gold over nickel or ... Gold flash over nickel palladium over nickel
Press-in zone plating	Tinlead over nickel

Physical data

Press-in Force	26 ± 6N/pin on nominal hole diameter (0.6 ± 0.05 mm)
Retention Force	
Mating force	20 ± 5N/pin on nominal hole diameter (0.6 ± 0.05 mm)
Withdrawal Force	0.75 N/contact max. 0.15 N/contact min.

PCB data

Diameter of plated through holes	0.6 ± 0.05 mm
Recommended PCB hole platings	Cu 25-50 µm, Sn or SnPb < 10 µm
PCB Thickness	1.4 – 5.6 mm

Valukumpu Oy ■ Raivaajantie 1 ■ FI-80100 Joensuu ■ Finland
 ■ Tel. +358-13-564 320 ■ Fax +358-13-313 600 ■ www.valukumpu.fi
 ■ e-mail: sales @valukumpu.fi



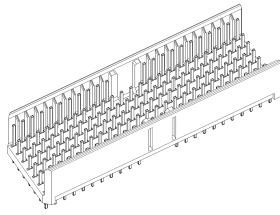

TYPE AB Male connectors, straight

Identification	Number of contacts	Performance level	Part number
----------------	--------------------	-------------------	-------------

TYPE AB 25

1	HM2AB25125M51010-Z011*636
1	HM2AB25125M51010-Z021*636
2	HM2AB25125M51010-Z012*636
2	HM2AB25125M51010-Z022*636

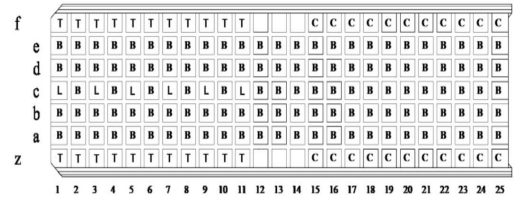

TYPE AB 25

1	HM2AB25125M51010-Z011*637
1	HM2AB25125M51010-Z021*637
2	HM2AB25125M51010-Z012*637
2	HM2AB25125M51010-Z022*637

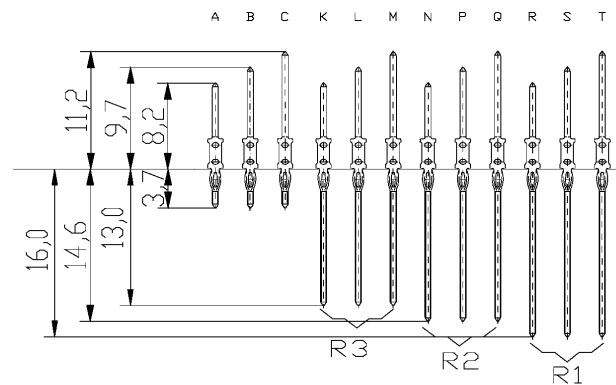
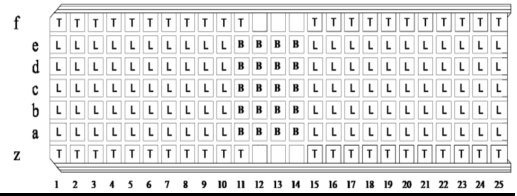

1 performance level (AU/NiPd 1,25 µm)
2 performance level (AU/NiPd 0,8 µm)

Valukumpu Oy ■ Raivaajantie 1 ■ FI-80100 Joensuu ■ Finland
 ■ Tel. +358-13-564 320 ■ Fax +358-13-313 600 ■ www.valukumpu.fi
 ■ e-mail: sales @valukumpu.fi



Valukumpu Oy

Rev. 1.1

Valukumpu Oy

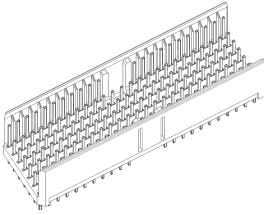

TYPE AB
Male connectors, straight

Mechanical dimensions and PCB layout

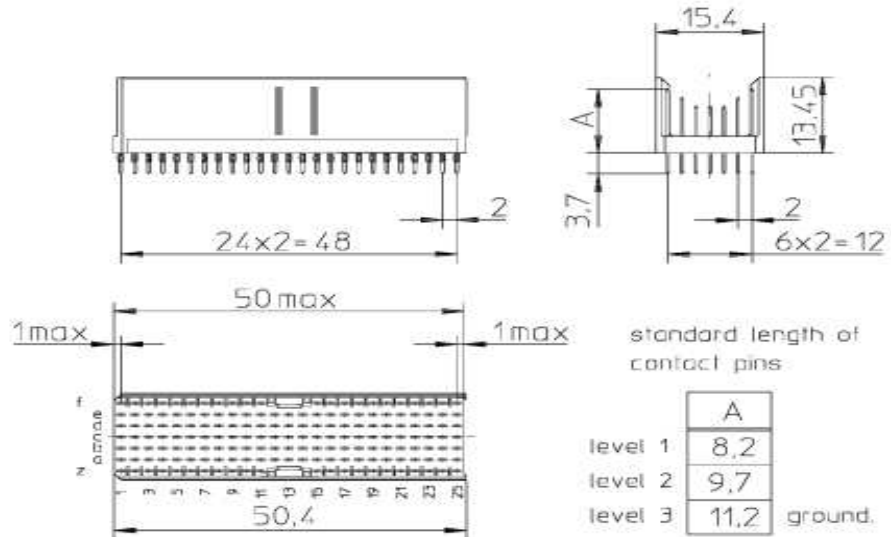

Front view back plain

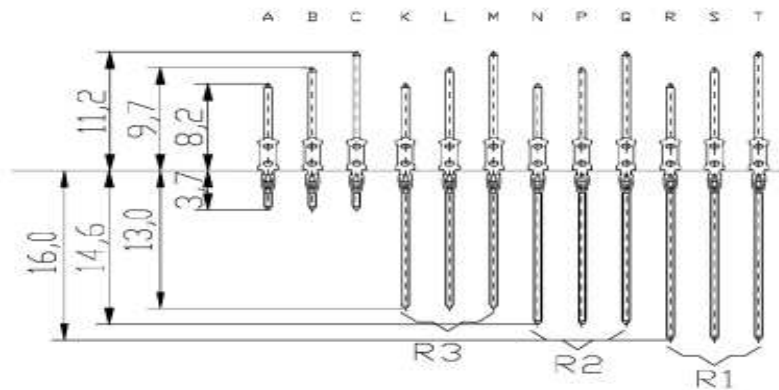
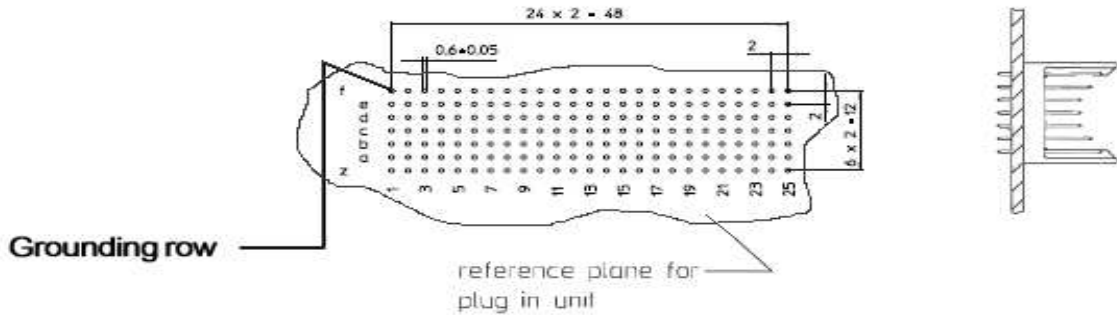

Valukumpu Oy ■ Raivaajantie 1 ■ FI-80100 Joensuu ■ Finland
 ■ Tel. +358-13-564 320 ■ Fax +358-13-313 600 ■ www.valukumpu.fi
 ■ e-mail: sales @valukumpu.fi



Valukumpu Oy

Rev. 1.1