

PerForm 2.0™ Hard Metric Connectors

Type A, Male

IEC 61076-4-101

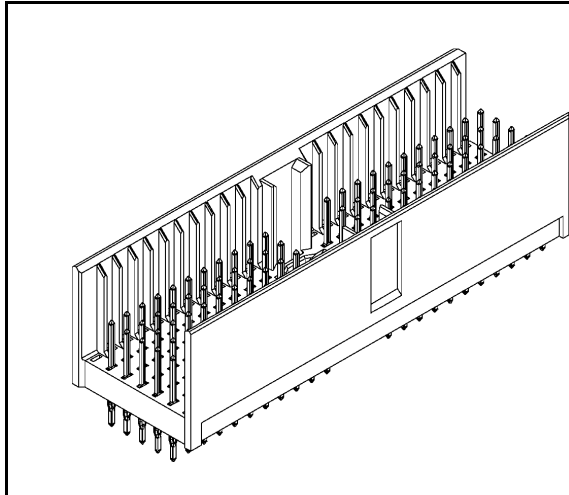

- According to IEC 61076-4-101 and IEC 917
- 25 mm basic system unit
- High contact density with 2 mm grid spacing
- 50 mm connector module
- Three different contact levels
- Different termination lengths available
- All terminations with compliant eye of needle press-fit design
- Plated through hole diameter 0.6 mm
- Available with grounding rows
- Different coding devices available

PRODUCT DATA

Electric data

Current rating	1 A at +70 °C
Test voltage	750 V AC (rms)
Insulation resistance	10 Gohm (min)
Temperature range	-55... +125 °C

Materials

Housing material	Thermoplastic resin, glass-fibre filled, UL 94 V-0
Contact material	Copper alloy
Contact plating	Gold over nickel or.. Gold flash over nickel palladium over nickel
Press-in zone plating	Tinlead over nickel

Physical data

Press-in Force	26 ± 6N/pin on nominal hole diameter (0.6 ± 0.05 mm)
Retention Force	
Mating force	20 ± 5N/pin on nominal hole diameter (0.6 ± 0.05 mm)
Withdrawal Force	0.75 N/contact max. 0.15 N/contact min.

PCB data

Diameter of plated through holes	0.6 ± 0.05 mm
Recommended PCB hole platings	Cu 25-50 µm, Sn or SnPb < 10 µm
PCB Thickness	1.4 – 5.6 mm

Valukumpu Oy ■ Raivaajantie 1 ■ FI-80100 Joensuu ■ Finland
 ■ Tel. +358-13-564 320 ■ Fax +358-13-313 600 ■ www.valukumpu.fi
 ■ e-mail: sales @valukumpu.fi



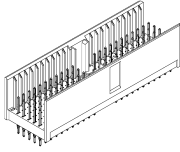

TYPE A Male connectors, straight

Identification	Number of contacts	Performance level	Part number
TYPE A 22	110	1	HM2A22110M51100-P211
	110	1	HM2A22110M51100-P221
	110	2	HM2A22110M51100-P212
	110	2	HM2A22110M51100-P222

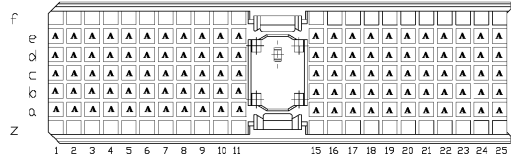

TYPE A 22	154	1	HM2A22110M51110-P211
	154	1	HM2A22110M51110-P221
	154	2	HM2A22110M51110-P212
	154	2	HM2A22110M51110-P222

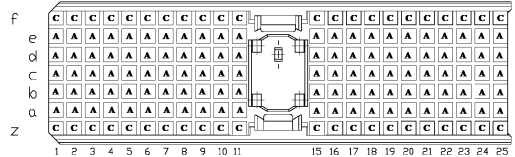

TYPE A 22	154	1	HM2A22110M51000-P211*348
	154	1	HM2A22110M51000-P221*348
	154	2	HM2A22110M51000-P212*348
	154	2	HM2A22110M51000-P222*348

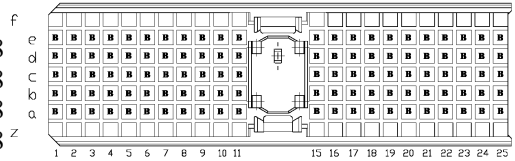

TYPE A 22	154	1	HM2A22110M51010-P211*341
	154	1	HM2A22110M51010-P211*341
	154	2	HM2A22110M51010-P212*341
	154	2	HM2A22110M51010-P222*341

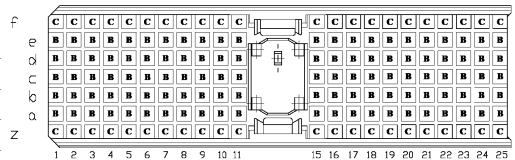

1 performance level (AU / NiPd 1,25 µm)
2 performance level (AU / NiPd 0,8 µm)

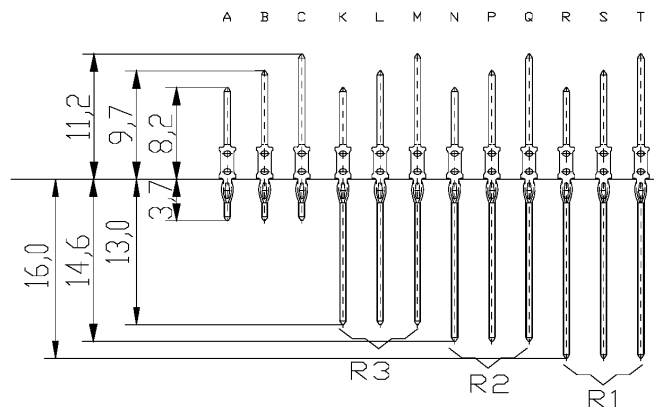

Valukumpu Oy ■ Raivaajantie 1 ■ FI-80100 Joensuu ■ Finland
 ■ Tel. +358-13-564 320 ■ Fax +358-13-313 600 ■ www.valukumpu.fi
 ■ e-mail: sales @valukumpu.fi



Valukumpu Oy

Rev. 1.2



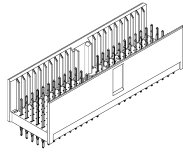

TYPE A Male connectors, straight

Identification	Number of contacts	Performance level	Part number	
TYPE A 22				
	110	1	HM2A22110M51100-R311	
	110	1	HM2A22110M51100-R321	
	110	2	HM2A22110M51100-R312	
	110	2	HM2A22110M51100-R322	
TYPE A 22				
	110	1	HM2A22110M51000-P211*286	
	110	1	HM2A22110M51000-P221*286	
	110	2	HM2A22110M51000-P212*286	
	110	2	HM2A22110M51000-P222*286	
TYPE A 22 Compact PCI P1/P4				
	154	1	HM2A22110M51010-P211*288	
	154	1	HM2A22110M51010-P221*288	
	154	2	HM2A22110M51010-P212*288	
	154	2	HM2A22110M51010-P222*288	
TYPE A 22 Compact PCI hot swap P1/P4				
	154	1	HM2A22110M51010-P211*294	
	154	1	HM2A22110M51010-P221*294	
	154	2	HM2A22110M51010-P212*294	
	154	2	HM2A22110M51010-P222*294	
TYPE A 22				
	130	1	HM2A22110M51010-Z011*592	
	130	1	HM2A22110M51010-Z021*592	
	130	2	HM2A22110M51010-Z012*592	
	130	2	HM2A22110M51010-Z022*592	
TYPE A 22				
	154	1	HM2A22110M51010-R311*593	
	154	1	HM2A22110M51010-R321*593	
	154	2	HM2A22110M51010-R312*593	
	154	2	HM2A22110M51010-R322*593	

