

PerForm 2.0™ Hard Metric Connectors

Type C, Male

IEC 61076-4-101

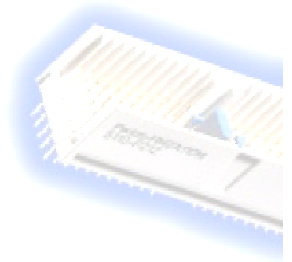

	<ul style="list-style-type: none"> - According to IEC 61076-4-101 and IEC 917 - 25 mm basic system unit - High contact density with 2 mm grid spacing - 50 mm connector module - Different termination lengths available - All terminations with compliant eye of needle press-fit design - Plated through hole diameter 0.6 mm - Available with grounding rows - Different coding devices available
--	---

PRODUCT DATA

Electric data

Current rating	1 A at +70 °C
Test voltage	750 V AC (rms)
Insulation resistance	10 Gohm (min)
Temperature range	-55... +125 °C

Materials

Housing material	Thermoplastic resin, glass-fibre filled, UL 94 V-0
Contact material	Copper alloy
Contact plating	Gold over nickel or.. Gold flash over nickel palladium over nickel
Press-in zone plating	Tinlead over nickel

Physical data

Press-in Force	26 ± 6N/pin on nominal hole diameter (0.6 ± 0.05 mm)
Retention Force	
Mating force	20 ± 5N/pin on nominal hole diameter (0.6 ± 0.05 mm)
Withdrawal Force	0.75 N/contact max. 0.15 N/contact min.

PCB data

Diameter of plated through holes	0.6 ± 0.05 mm
Recommended PCB hole platings	Cu 25-50 µm, Sn or SnPb < 10 µm
PCB Thickness	1.4 – 5.6 mm

Valukumpu Oy ■ Raivaajantie 1 ■ FI-80100 Joensuu ■ Finland
 ■ Tel. +358-13-564 320 ■ Fax +358-13-313 600 ■ www.valukumpu.fi
 ■ e-mail: sales @valukumpu.fi



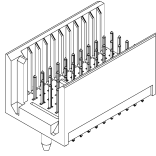

TYPE C Male connectors, straight

Identification	Number of contacts	Performance level	Part number	
TYPE C11	55	1	HM2C11055M51100-P211	
	55	1	HM2C11055M51100-P221	
	55	2	HM2C11055M51100-P212	
	55	2	HM2C11055M51100-P222	
TYPE C11	77	1	HM2C11055M51110-P211	
	77	1	HM2C11055M51110-P221	
	77	2	HM2C11055M51110-P212	
	77	2	HM2C11055M51110-P222	
TYPE C11	55	1	HM2C11055M51000-P211*373	
	55	1	HM2C11055M51000-P221*373	
	55	2	HM2C11055M51000-P212*373	
	55	2	HM2C11055M51000-P222*373	
TYPE C11	77	1	HM2C11055M51010-P211*361	
	77	1	HM2C11055M51010-P221*361	
	77	2	HM2C11055M51010-P212*361	
	77	2	HM2C11055M51010-P222*361	

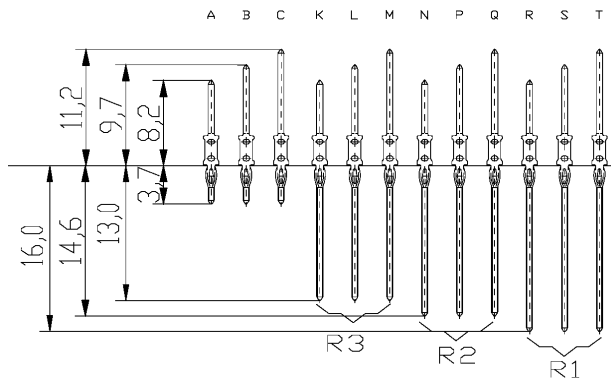

1 performance level (AU / NiPd 1,25 µm)
2 performance level (AU / NiPd 0,8 µm)

Valukumpu Oy ■ Raivaajantie 1 ■ FI-80100 Joensuu ■ Finland
 ■ Tel. +358-13-564 320 ■ Fax +358-13-313 600 ■ www.valukumpu.fi
 ■ e-mail: sales @valukumpu.fi



Valukumpu Oy

Rev. 1.3



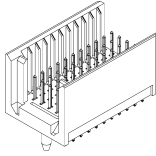

TYPE C Male connectors, straight

Identification	Number of contacts	Performance level	Part number	
TYPE C11	55	1	HM2C11055M51100-R311	
	55	1	HM2C11055M51100-R321	
	55	2	HM2C11055M51100-R312	
	55	2	HM2C11055M51100-R322	
TYPE C11	77	1	HM2C11055M51010-P211*315	
	77	1	HM2C11055M51010-P221*315	
	77	2	HM2C11055M51010-P212*315	
	77	2	HM2C11055M51010-P222*315	
TYPE C11	77	1	HM2C11055M51110-P211*659	
	77	1	HM2C11055M51110-P221*659	
	77	2	HM2C11055M51110-P212*659	
	77	2	HM2C11055M51110-P222*659	
TYPE C11	55	1	HM2C11055M51000-P211*286	
	55	1	HM2C11055M51000-P221*286	
	55	2	HM2C11055M51000-P212*286	
	55	2	HM2C11055M51000-P222*286	
TYPE C11	77	1	HM2C11055M51010-P211*457	
	77	1	HM2C11055M51010-P221*457	
	77	2	HM2C11055M51010-P212*457	
	77	2	HM2C11055M51010-P222*457	

1 performance level (AU / NiPd 1,25 µm)
2 performance level (AU / NiPd 0,8 µm)

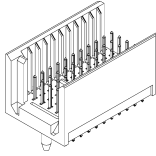

TYPE C Male connectors, straight

Mechanical dimensions and PCB layout

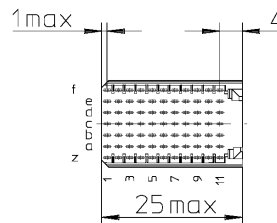
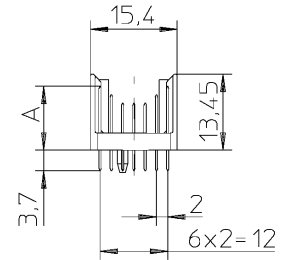
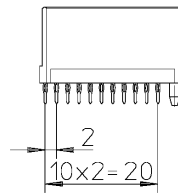
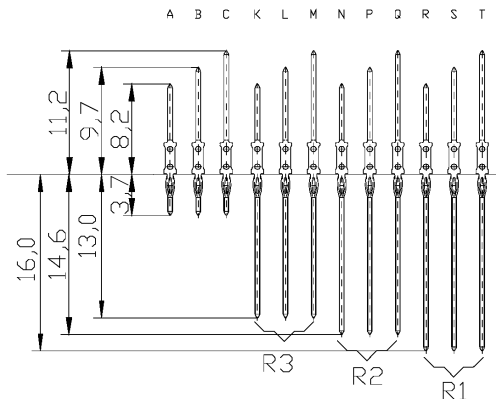

standard length of contact pins

	A
level 1	8,2
level 2	9,7
level 3	11,2 ground.

Front view back plain

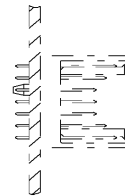
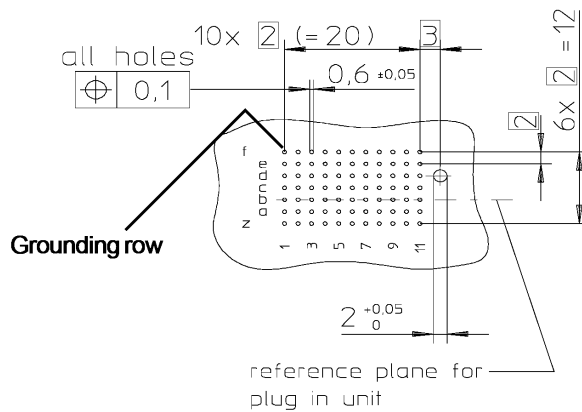

- 1 performance level (AU / NiPd 1,25 μm)
- 2 performance level (AU / NiPd 0,8 μm)

Valukumpu Oy ■ Raivaajantie 1 ■ FI-80100 Joensuu ■ Finland
 ■ Tel. +358-13-564 320 ■ Fax +358-13-313 600 ■ www.valukumpu.fi
 ■ e-mail: sales @valukumpu.fi



Valukumpu Oy

Rev. 1.3

